



Design, calculations and manufacturing
of **Storage Systems**



DYNAMIC SHELVES

The **Strength** of simplicity



We have a background of more than **50 years of knowledge** in the design and manufacturing of Storage Systems. We have consolidated and strengthened our position based on the humility and freshness of a young and specialized team, which added to our latest generation technologies, makes **ESNOVA** enjoy the trust and confidence of our worldwide customers.



WE EXPORT TO OVER THAN **30 COUNTRIES**

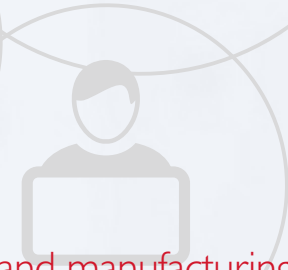

Design, calculations and manufacturing of **Storage Systems**



EXPERIENCE

We have a large group of professionals with a long career in the logistics sector.

We can give you an efficient and direct response. We count with a large variety of references in stock for delivery in a few days and we adapt to special requirements for any type of business and storage. From the lightest shelving to the most sophisticated automatic storages.

We always offer efficient storages by studying each case and adapting the best solution for it:

- Optimize the available space.
- Increase storage capacity.
- Make the square metre of storage more profitable.
- Provide a more logical order for easy location and greater protection against damages and losses.
- More security for staff and facilities.
- Generate higher productivity in operations and resources.
- Offer a better service to our customers.



SOLUTIONS

Industrial racking/shelving to store all types of products. Light, medium and heavy loads, palletised loads, big loads...

Standard Pallet Racking, Drive-in Racking, Cantilever, Rack-clad storage systems and automatic systems, Long Span racking, Boltless shelving (Riveto), Multi-tier shelving, mezzanines, metallic containers. All of them formed a great range of storage solutions which, together with our experienced team, will solve your storage problems with quality, safety and lower cost.



Technology

Our machinery at your service. We are equipped with the most flexible and advanced production systems for the design and manufacture of parts, components and competitive metal products.



Lab Tests

We have a Testing Laboratory where the performance of all different components of each system is verified by testing loads, resistance, buckling ...



Innovation

Innovate to improve, both in **new products** and in the optimization of existing products.

Quality



Esnova sets as a priority the quality standards in each and every one of the processes it develops.

- Certificate in the quality management system (ISO 9001).
- Certificate in the environmental management system (ISO 14001).
- Certificate in the occupational health and safety management system (OHSAS 18001).
- UNE EN 1090 Certificate of CE Marking.
- Member of the European Federation of Maintenance FEM/AEM.



Management System
ISO 9001:2015
ISO 14001:2015
OHSAS 18001:2007
EN 1090
www.tuv.com
ID 9105076955

PALLET DYNAMIC

COMPACT DEEP LOAD STORAGE SYSTEM.

·System where pallets are deposited from the loading aisle on roller tracks, placed with a slight slope, which permit their displacement by gravity. These pallets move at a controlled speed and are positioned at the opposite end to the one accessed from the unloading aisle.

·This design, in its FIFO system, allows a perfect rotation of the product in the warehouse, being the first pallet to enter the first to leave.

·The simplicity of this storage system increases the profitability of the warehouse, makes the most of the storage space and considerably reduces operator movements.



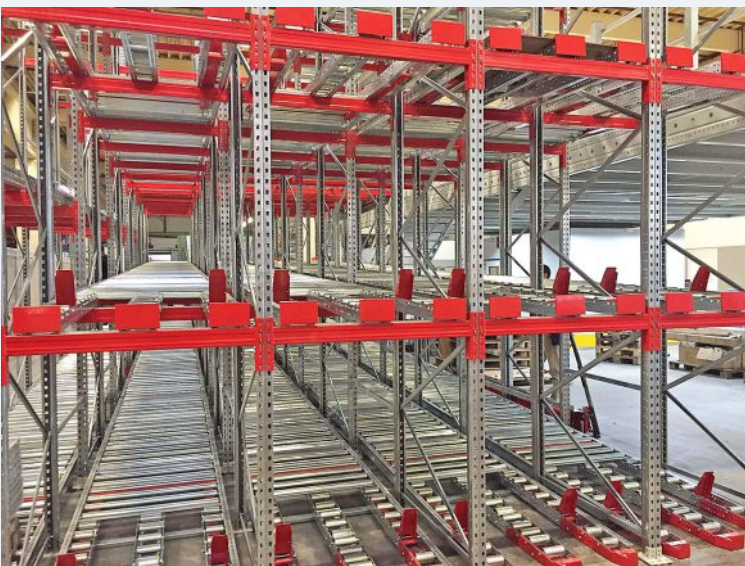

SYSTEM BENEFITS



PRECISION AND SPEED. REDUCTION OF WORKING TIMES COMPARED TO A CONVENTIONAL COMPACT SYSTEM.



HIGH STORAGE DENSITY. THE WAREHOUSE VOLUME IS USED TO THE FULL, AS IT REQUIRES ONLY TWO ACCESS CORRIDORS, THE LOADING AND UNLOADING CORRIDORS.



GREAT ACCESSIBILITY TO THE PRODUCTS.



LESS PASSING INTERFERENCE. SINCE THE LOADING AISLES ARE DIFFERENT FROM THE UNLOADING AISLES, THE FORKLIFTS THAT DEPOSIT THE LOAD AND THOSE THAT EXTRACT IT DO NOT INTERFERE.



OPTIMAL SYSTEM FOR HIGH ROTATION CYCLES. EACH WORKING POSITION IS INDEPENDENT OF THE OTHERS.

FIFO SYSTEM - LIFO SYSTEM.



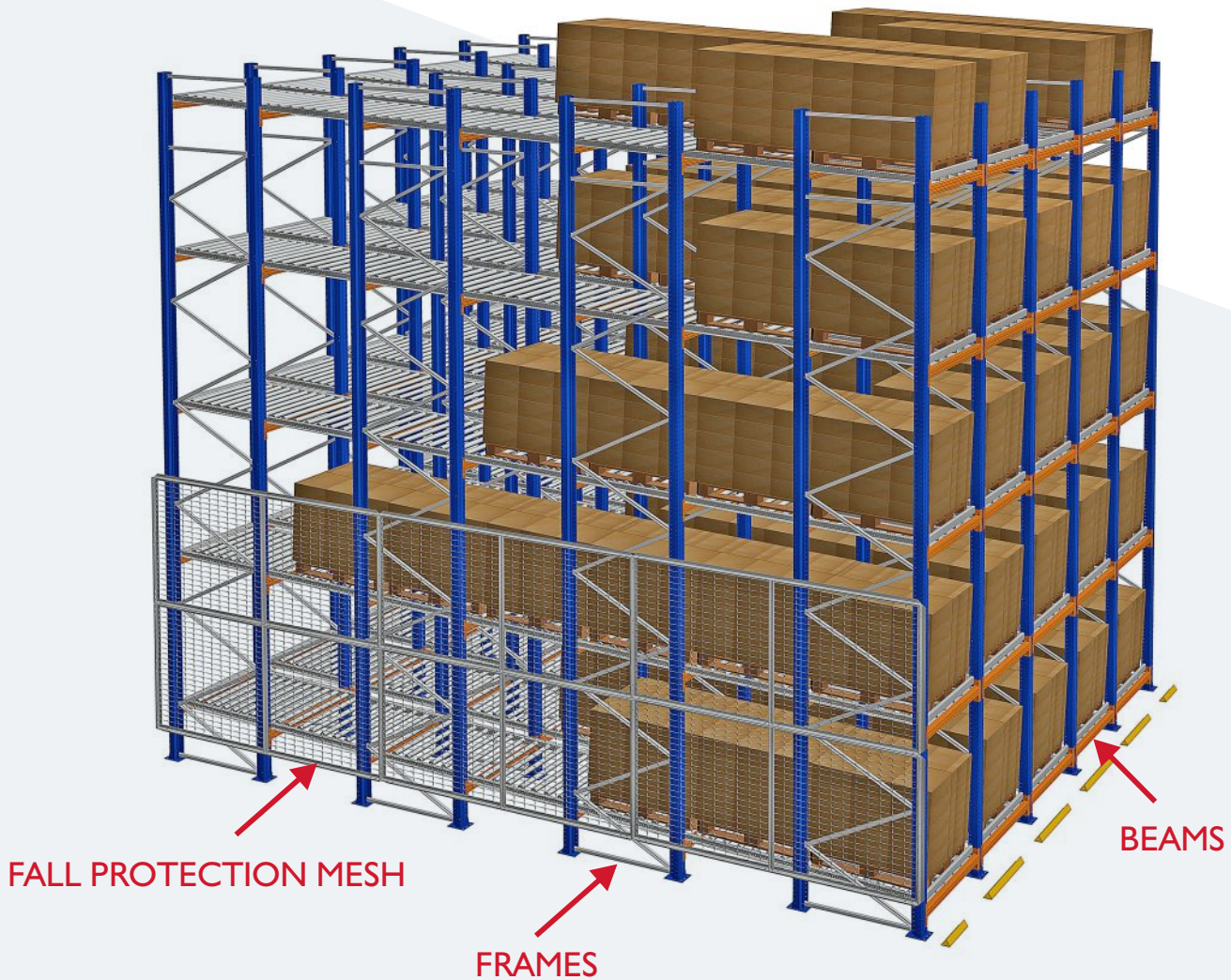

ROLLER CONVEYORS

Set of elements used to support the pallets. Composed of rollers and support profiles. They can include speed controllers and pallet separators.



PROTECTIONS AND STOPS

Forklift stops, side guards, front guards, etc. Elements to guarantee the safety of the installation, the operators and the integrity of the loads.

LIFO SYSTEM

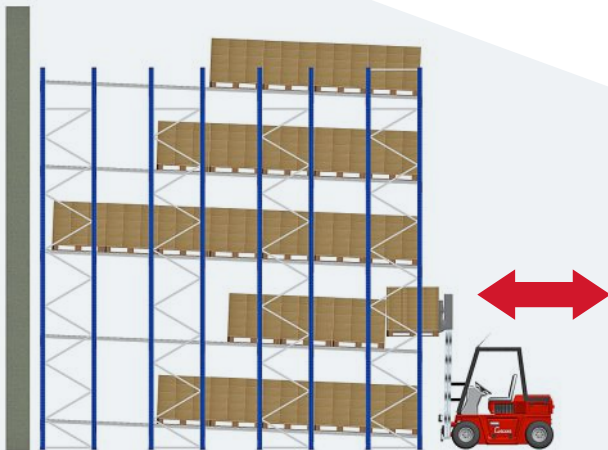

The pallet is introduced in the loading aisle and by gravity it slides over the rollers to the opposite side, where the unloading aisle is located.

The last pallet in is the first one out.

This LIFO system is compatible with both roller and push-back platforms.

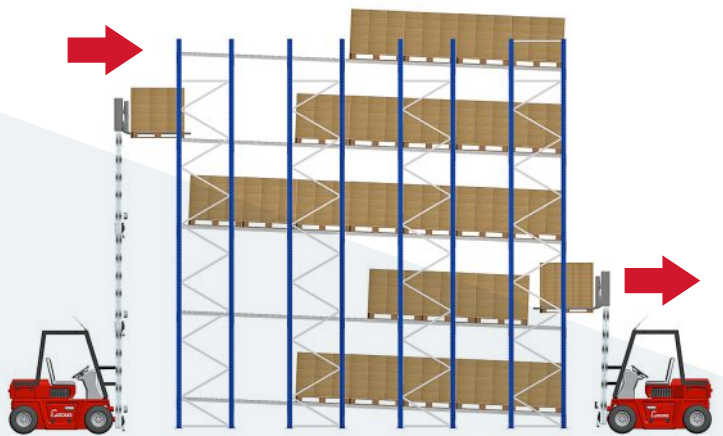

The pallet is introduced in the loading aisle and by gravity it slides over the rollers to the opposite side, where the unloading aisle is located.

The first pallet in is the first pallet out.

When it comes to perishable products, it is the most suitable system, as it is the oldest product that leaves the warehouse first.

The method of storage and placement of this type of products is particularly important. They should be placed in such a way to make it as easy as possible for products that have a shorter expiry date to leave, avoiding damage to the goods before they are used.

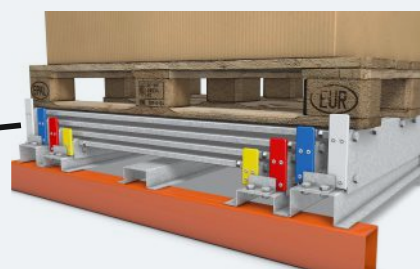

FOLDING ROLLER CONVEYORS

In several occasions and due to the stored products, especially in food sectors, it is necessary to access the floor for cleaning and maintenance work. There is the possibility of installing folding roller conveyors that facilitate these actions easily and simply.





The dynamic pallet system can be combined with **picking** operations.

The lower level of the system can be used for manual picking functions, providing great agility in the preparation of orders. As the entrance to the roller conveyor is at ground level, it is adapted to facilitate the use of a pallet truck.

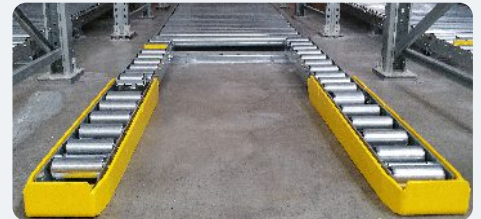

DYNAMIC WITH HIGH AISLES

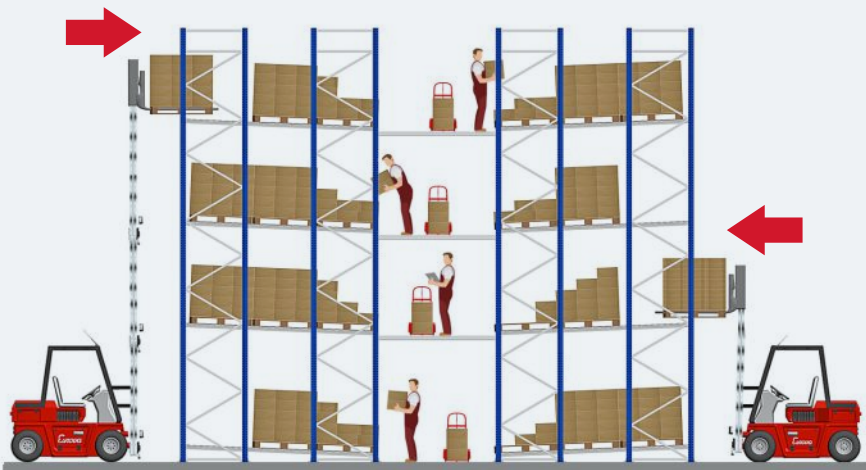

Configuration of dynamic picking stations in a plant with high aisles.

The forklifts deposit the pallets on the roller tracks and these, by the effect of gravity, move to the opposite end where the operator performs the necessary picking functions.

AUTOMATIC WAREHOUSE WITH PALLET FLOW SYSTEM

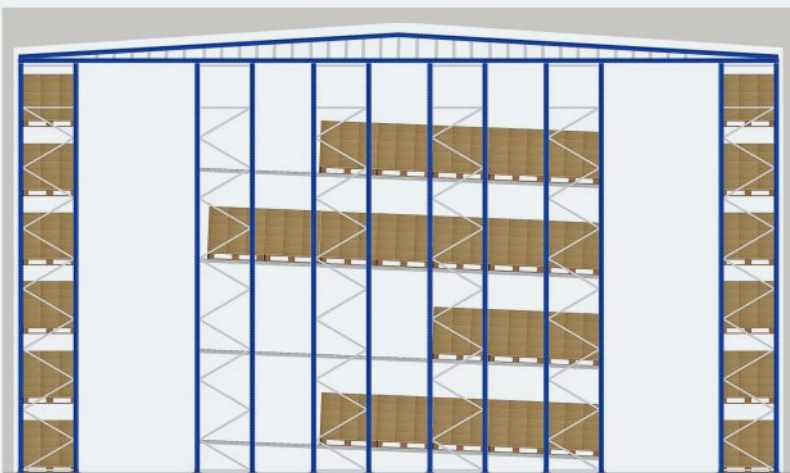

Automatic warehouses can accommodate configurations with pallet dynamics.

Automatic systems with dynamic shelving are designed for high consumption products where rotation is very important. They can be served by stacker cranes or more conventional machines such as forklifts.

DYNAMIC FOR BOXES (PICKING)

MANUAL STORAGE SYSTEM BY ACCUMULATION.

·System of individual frames and uprights connected to each other, which allow the storage of containers and boxes in depth. It is equipped with rollers or sheaves that facilitate the movement by gravity of the load units. This system is usually of the FIFO type (first in - first out).

·This design allows a perfect rotation of the product in the warehouse, being the ideal storage system by accumulation when it is necessary to prepare a great quantity of orders with many references.

·The simplicity of this storage system increases the profitability of the warehouse, bringing the stored units closer to the operators, so that they have to move around as little as possible.

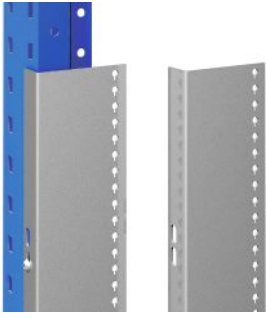

MOUNTING CONNECTOR

Piece that connects the beams to the structure where the pulley ways sit.



PICKING TRAY

Structure that supports the wheel tracks. Composed of a front profile, a rear profile and two side profiles connected by internal crossbeams.

SPEED CONTROLLER

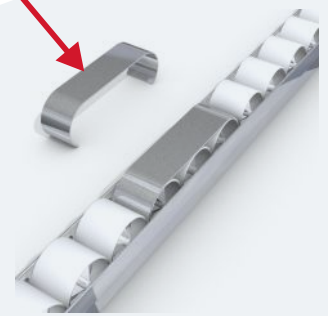

ROLLER TRACK

Made up of high-quality sheaves with a reinforced steel axle. Speed controllers can be incorporated for the goods.

OPTIONAL ITEMS

- * Lateral separators. No tools are needed for placement or adjustment.
- * Order preparation tray.
- * Front label holder strip.

LATERAL SEPARATOR

ORDER PREPARATION TRAY

FRONT LABEL HOLDER STRIP



THE DYNAMIC PICKING SYSTEM CAN BE CONFIGURED IN TWO WAYS, FORMING A COMPLETE INSTALLATION OR BEING PART OF A PALLET RACK OR MANUAL RACK INSTALLATION, BEING LOCATED ON THE LOWER LEVELS.



The **Strength** of simplicity

WE DESIGN AND MANUFACTURE STORAGE SYSTEMS
FROM THE MOST BASIC OPTION TO THE MORE SOPHISTICATED ONE.



PLEASE ASK FOR OUR
CATALOGUES OR DOWNLOAD
THEM FROM OUR WEBSITE.

WWW.GAWELA.CH



Management System
ISO 9001:2015
ISO 14001:2015
OHSAS 18001:2007
EN 1090
www.tuv.com
ID 9105076955

ESNOVA SOFTWARE WHAREHOUSE MANAGEMENT SOFTWARE

¿HOW TO ORGANIZE A WHAREHOUSE?

This software specially designed to the warehouse management is the perfect IT tool to have a logistic control of your storage space.



MULTI-DEVICE SOFTWARE

GAWELA GmbH

KonstanZerstrasse 14, CH-8274 Tägerwilen

+41 71 6670000

info@gawela.ch